

# PFV SERIES

## 2/2 PROPORTIONAL SOLENOID VALVES

PFV liquid and gas 2/2 proportional solenoid valves simplify design and construction of medical, life-science, semiconductor and other OEM equipment. PFV valves feature a wetted path made of 300 and 400 series stainless steel and FKM, FKM (NSF Certified), EPDM and FFKM seal options.

PFV proportional solenoid valves flow not only air and water but also the most challenging media. Available in seven available orifice sizes ranging from  $\varnothing 0.5$  mm (0 to 130 mLPM liquid and 0 to 4.3 SLPM gas) to  $\varnothing 1.75$  mm (0 to 2.5 LPM liquid and 0 to 140 SLPM gas).



## KEY ADVANTAGES

### \* 6 ORIFICE SIZES

Seven available orifice sizes ranging from the ultra-low flow  $\varnothing 0.5$  mm (0 to 130 mLPM liquid and 0 to 4.3 SLPM gas) to  $\varnothing 1.75$  mm (0 to 2.5 LPM liquid and 0 to 140 SLPM gas)

### \* LASER MARKED TRACEABILITY

Each PFV is laser marked with serial number and date and time code allowing traceability back to the original calibration and performance data

### \* SELECTABLE INPUT PRESSURE

Each PFV is individually calibrated for the inlet and outlet pressure range of the application. Available from 0...10 bar (0...145 psi).

### \* 6 DRIVER OPTIONS

Six driver options (12Vdc or 24Vdc power with 0...5Vdc, 0...10Vdc or 0...20m command input). Optimized for the PFV series and designed to minimize fluctuations based on temperature and power.

### \* 4 SEAL OPTIONS

FKM, FKM (NSF Certified), FFKM and EPDM seal options provide compatibility with a maximum range of liquids and gases

### \* IP67 RATING

Able to handle tough environments while staying protected against both dust and water ingress.

## MECHANICAL SPECIFICATIONS

---

**Valve Type:**

2-Way Proportional Normally Closed

**Connector:**

Wire Leads - 22 Gauge, 491mm length

**Media:**

Neutral Gases, Oxygen, Liquids. Other Compatibilities Available

**Gating Element:**

Poppet Seat Valve

**Mounting:**

10-32 UNC Male Stud or 2x 10-24 UNC

**Diameter:**

26.0 mm (1.02 in)

**Environmental Protection Class:**

IP67

**Operating Temperature:**

-20...50C (-4...122F)

**Height:**

62.5 to 76.0 mm (2.46 to 3.0 in)

**Ports:**

Concentric Porting with 10-32 Male Stud or 1/8" NPT Ports

**Filtration:**

5 um Particulate

**Burst Pressure:**

35 bar (500 psi)

**Leak Rate:**

< 10 sccm (based on SKU)

## ELECTRICAL SPECIFICATIONS

---

(for valves without onboard electronics):

**Nominal Coil Resistance:**

16.6Ω or 65Ω

**Maximum Coil Voltage:**

12VDC or 24VDC

**Current for Full Open:**

350mA or 175mA

**Nominal Maximum Power Consumption:**

2.1W

## WETTED MATERIAL SPECIFICATIONS

---

**Body:**

316 Series Stainless Steel

**Seals:**

FKM, FKM (NSF® certified), FFKM or EPDM - other materials available on request

**Moving Elements:**

430 Series Stainless Steel  
302 Series Stainless Steel  
304 Series Stainless Steel

## VALVE DESIGN

With its unique, patented triple spring technology (balance - guide - control), the PFV series of valves produces highly linear flow curves that can be calibrated to the ideal inlet air pressure based on the flow required. This ensures consistent current liftoff from valve to valve and application to application.

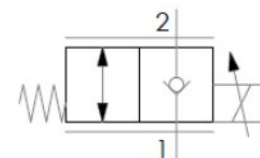

## DESIGN FEATURES

Onboard electronics available for optimized control, consistent performance and quick set up

Wire numbering on cap makes consistent wiring in OEM applications easy

Each valve is laser marked at end-of-line with date and time traceable serial number

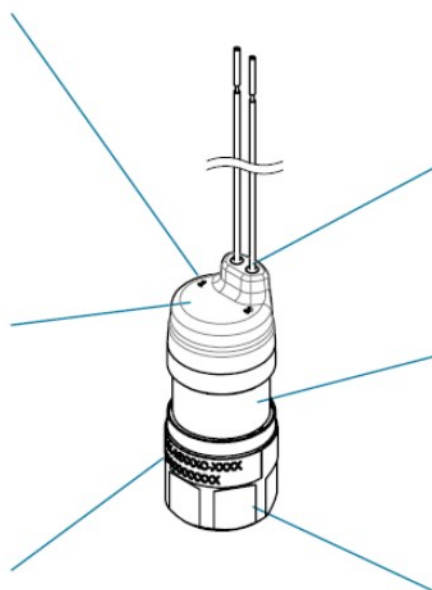

Fully-sealed wire leads help maintain the valve's IP67 ingress protection rating

Body made from 300 and 400 series stainless steel for maximum chemical and media capability

24mm hex flats allow for easy mounting and tightening of valve to the correct torque specification

## COIL CHARACTERISTICS AND ELECTRICAL PROPERTIES

(NO ONBOARD ELECTRONICS)

Coil Order Code	Resistance	Input Current	Max Voltage	Nominal Power Consumption
<b>12</b>	16.6 Ω	0...350mA	12Vdc	2.1W
<b>24</b>	65.0 Ω	0...175mA	24Vdc	2.1W



Example: PFV-W**24**-M175C-0100 would have a 65.0Ω coil and would take a 0...175mA input

## ELECTRICAL PROPERTIES

(WITH ONBOARD ELECTRONICS)

The PFV comes with three available onboard driver options engineered to optimize the performance of the valve. These electronics were designed especially for the PFV, helping users avoid the expense and effort of characterizing valves and developing electronics. This is ideal for users who have tight project deadlines, want to get to market quickly and are looking for a plug-and-play device that can be up and running in a short amount of time. Additionally, since these electronics sit under the cap of the valve, the valve is able to maintain its IP67 rating



Wire	Function	Input & Impedance
1 (brown)	DC Power	<b>12:</b> 12Vdc <b>24:</b> 24Vdc
2 (blue)	DC Common & Command -	0 Vdc
3 (black)	Command+	<b>E01:</b> 0...10Vdc (3.24k Ohm) <b>E02:</b> 0...20mA (280 Ohm) <b>E05:</b> 0...5Vdc (73.6k Ohm)

- Automatically Adjusts for Changes in Coil Resistance due to Temperature
- Reverse Polarity Protection
- Closed Loop Current Design
- Wide Temperature Range
- Overvoltage Protection
- Designed for Continuous Use
- Low Power Consumption
- Compact Size - Fits Under Cap
- Maintains IP67 Rating
- Handles Power Supply Fluctuations

Example: PFV-W**12E01**-M175C-0100 would require a 12Vdc power supply and take a 0...10Vdc command input

## FLOW GRAPHS FOR EACH ORIFICE

Ø0.50 mm Orifice

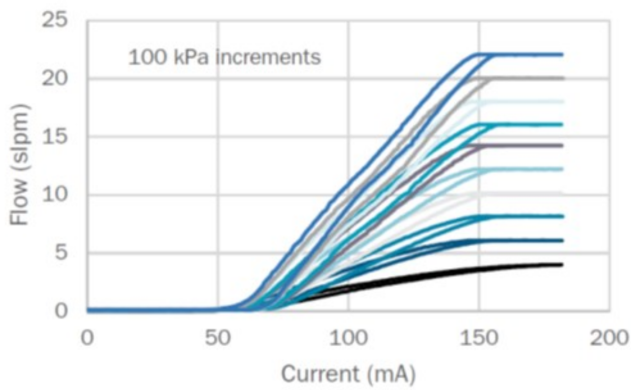

Ø0.75 mm Orifice

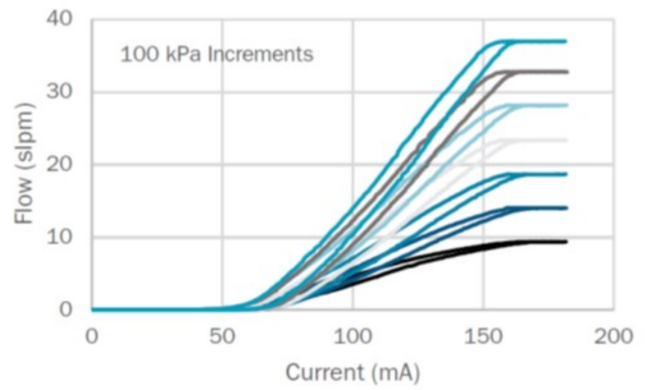

Ø1.00 mm Orifice

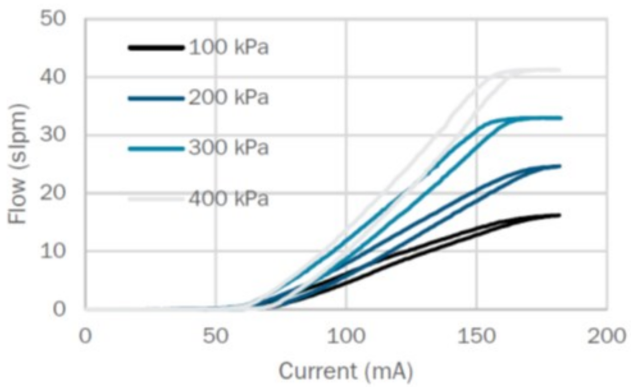

Ø1.25 mm Orifice

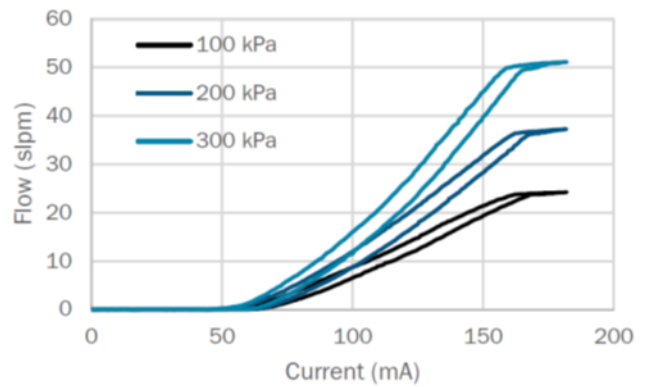

Ø1.50 mm Orifice

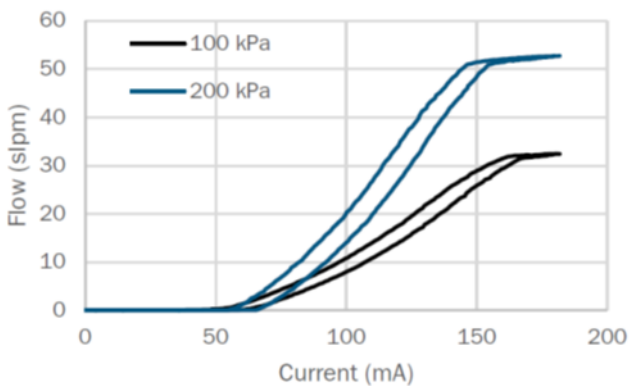

Ø1.75 mm Orifice

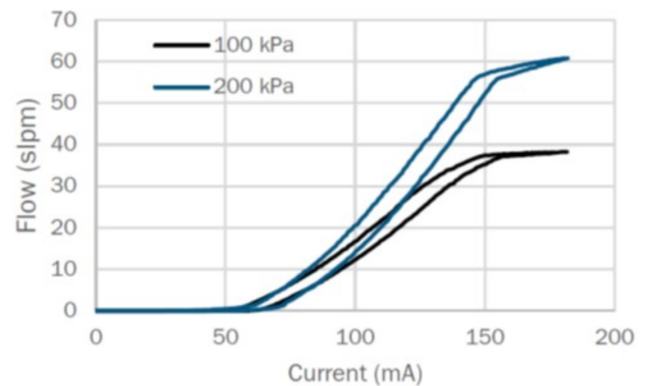

## MAXIMUM FLOW RATES (AIR & WATER)

Maximum Flow Rate vs. Upstream Pressure - Air

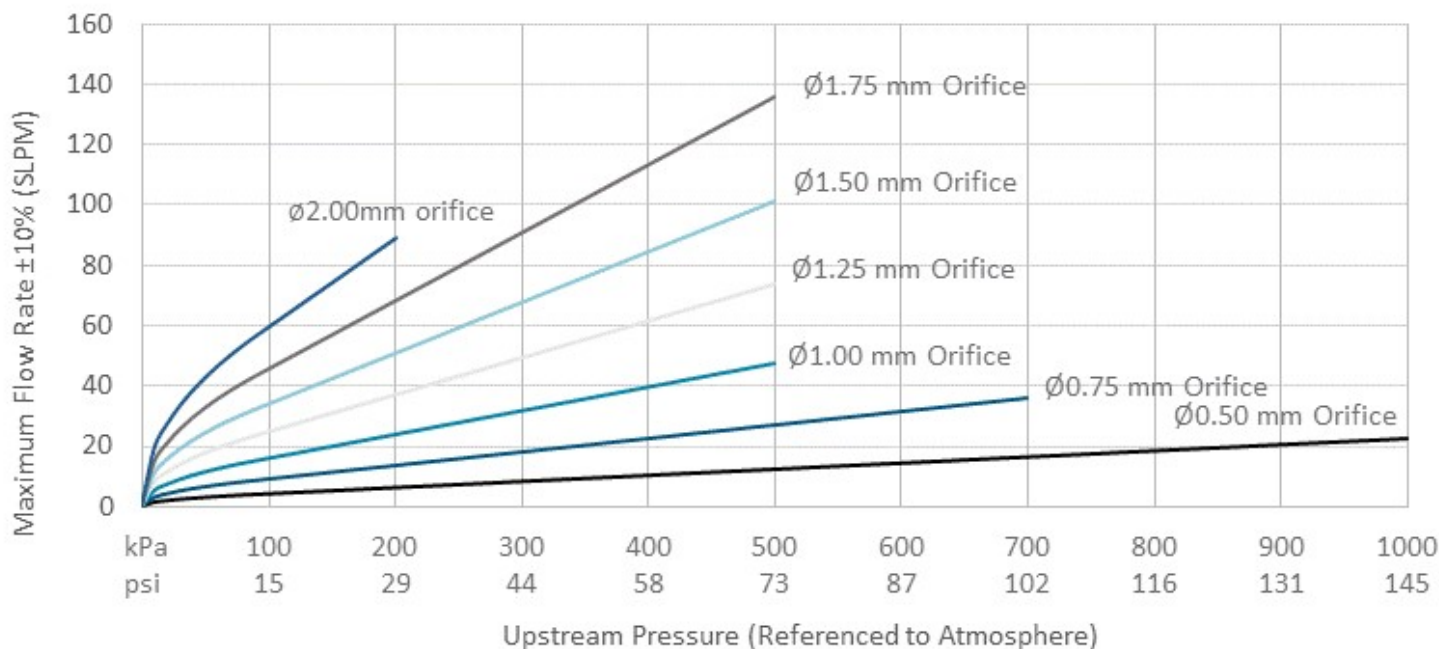

Maximum Flow Rate vs. Upstream Pressure - Water

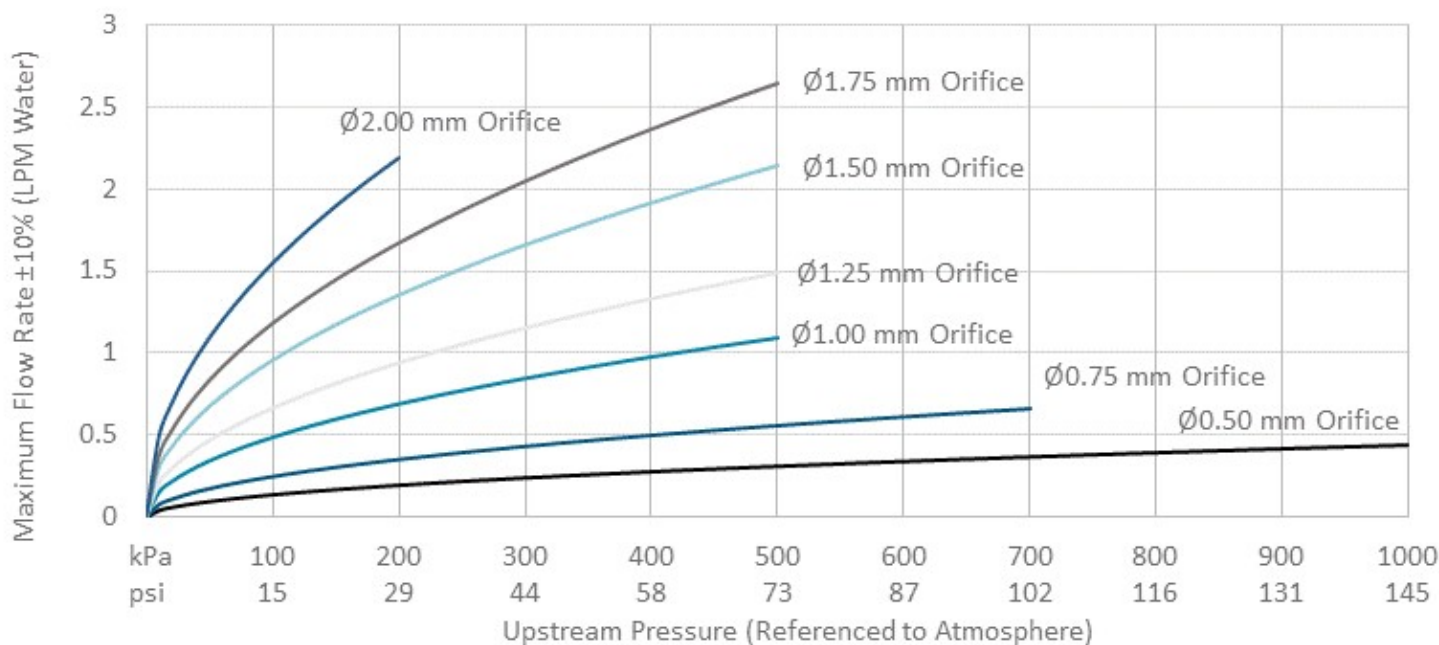

## NSF CERTIFIED PROPORTIONAL VALVES

FOR USE IN BEVERAGE DISPENSING EQUIPMENT

PFV 2/2 proportional solenoid valves certified to NSF/ANSI Standard 18 for Food & Beverage Dispensing Equipment. Featuring a wetted path made of 300 and 400 series stainless steel with FDA Standard CFR 21 177.2600 compliant FKM seals. Materials designed for use with water and alcohol.



Available in six available orifice sizes ranging from Ø0.5 mm (0 to 130 mLPM liquid) to Ø1.75 mm (0 to 2.5 LPM liquid) the PFV is ideal for your potable water application. Use order code 'N' for the material selection when ordering



The PFV Miniature Proportional Valves simplify design and installation for makers of medical, life science, semiconductor and other OEM equipment by providing repeatable, accurate flow in response to input current. With seven available orifice sizes ranging from Ø0.5 mm to Ø1.75 mm, choosing a valve based on inlet air pressure and required flow becomes easy. Each valve and orifice combination is then individually calibrated to maximize linearity and minimize hysteresis, providing top of the line performance in a small package size.

## PFV ORDER CODES

PFV-W 24 E05-M 175 C- 0100

Order Code	Max Coil Voltage
12	12Vdc
24	24Vdc

Order Code	Electronics
Blank	No Elex
E01	0...10Vdc
E02	0...20mA
E05	0...5Vdc

Order Code	Body
M	10-32 Stud
P	1/8" NPT

Order Code	Orifice Diameter
050	Ø0.50mm
075	Ø0.75 mm
100	Ø1.00 mm
125	Ø1.25 mm
150	Ø1.50 mm
175	Ø1.75 mm
200	Ø2.00 mm

Calibration Pressure
Select the maximum pressure that the valve will operate at.
Example: A valve with order code 0100 is calibrated for use with 100kPa (14.5psi) max inlet pressure.
Increments of 100 kPa can be specified.

Order Code	Seals
C	FKM
E	EPDM
K	FFKM
N	NSF® FKM



## ACCESSORIES

---



### A-MFD-01-001

Stainless Steel PFV Single-Valve Manifold with 10-32 Ports

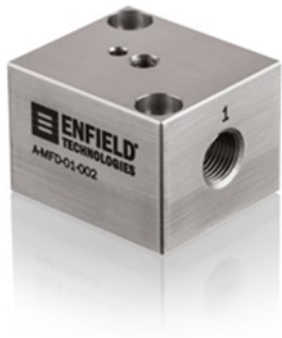

### A-MFD-01-002

Stainless Steel PFV Single-Valve Manifold With 1/8 NPT Ports



### A-MFD-04-002

Stainless Steel PFV Four-Valve Manifold with 1/8 NPT Ports

## CUSTOMIZATIONS

---

Enfield provides a number of custom options to make integration of PFV proportional valves easier, expand performance or meet the needs of customer specific applications.



### CUSTOM CONNECTORS

Standard wire leads can be terminated into custom connectors for easy integration, greater protection, and a reduction in wiring mistakes in OEM applications.

### CUSTOM VALVE BODIES

Custom mounting options for application specific needs



### COMPLETE CUSTOM ASSEMBLIES

Complete solutions can be customized with customer specific manifolds, fittings, connectors, and control & drive electronics.

**Enfield Technologies** is an expert in high performance proportional control systems. Our standard product line focuses on pneumatics. With custom products and engineering services, we also apply our expertise in other areas of fluid power, electromechanical systems, and control electronics. New developments in pneumatic technology are opening doors for design engineers to create unique, market leading products and systems.

Enfield Technologies is leading this innovation. Our control valves and electronics solve many of the challenges posed by compressible fluids. The additional functionality and performance from Enfield Technologies helps our customers create breakthrough applications and enhance existing systems. Simply put, we make pneumatics do things that others declare impossible.

**Enfield Technologies**  
35 Nutmeg Drive  
Suite 130  
Trumbull, CT 06611 USA

+1 203 375 3100  
[enfieldtech.com](http://enfieldtech.com)

